

CLC406

Wideband, Low Power Monolithic Op Amp

General Description

The CLC406 is a wideband monolithic operational amplifier designed for low gain applications where power and cost are of primary concern. Operating from $\pm 5V$ supplies, the CLC406 consumes only 50mW of power yet maintains a 160MHz small signal bandwidth and a 1500V/ μs slew rate. Benefiting from National's current feedback architecture, the CLC406 offers a gain range of ± 1 to ± 10 while providing stable, oscillation free operation without external compensation, even at unity gain.

With its exceptional differential gain and phase typically 0.02% and 0.02° at 3.58MHz, the CLC406 is designed to meet the performance and cost requirements of high volume composite video applications. The CLC406's large signal bandwidth, high slew rate and high drive capability are features well suited for RGB video applications.

Providing a 12ns settling time to 0.05% (1/2 LSB in 10-bit systems) and $-68/-75$ dBc 2nd/3rd harmonic distortion ($2V_{PP}$ at 10MHz, $R_L = 1k\Omega$), the CLC406 is an excellent choice as a buffer or driver for high speed A/D and D/A converter systems.

Commercial remote sensing applications and battery powered radio transceivers requiring a high performance, low power amplifier will find the CLC406 to be an attractive, cost effective solution.

Constructed using an advanced, complementary bipolar process and National's proven current feedback architectures, the CLC406 is available in several versions to meet a variety of requirements.

Features

- 160MHz small signal bandwidth
- 50mW power ($\pm 5V$ supplies)
- 0.02%/0.02° differential gain/phase
- 12ns settling to 0.05%
- 1500V/ μs slew rate
- 2.2ns rise and fall time ($2V_{PP}$)
- 70mA output current

Applications

- Video distribution amp
- HDTV amplifier
- Flash A/D driver
- D/A transimpedance buffer
- Pulse amplifier
- Photodiode amp
- LAN amplifier

Small Signal Pulse Response

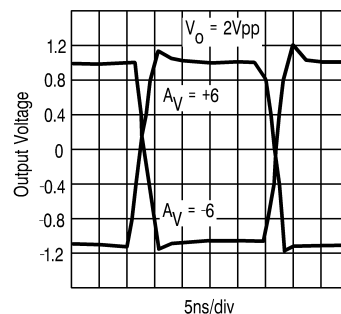

DS012747-17

Connection Diagrams

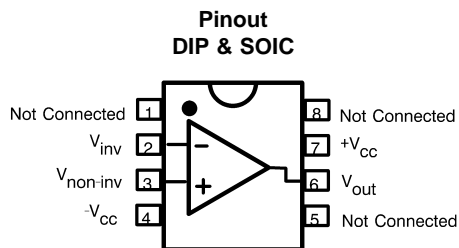

DS012747-16

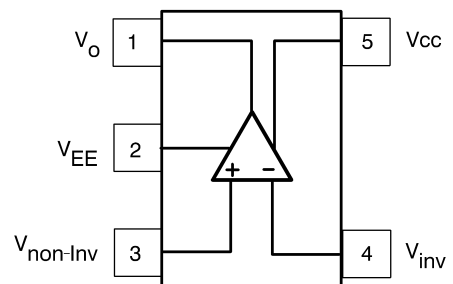

DS012747-15

**Pinout
SOT23-5**

Ordering Information

Package	Temperature Range Industrial	Part Number	Package Marking	NSC Drawing
8-pin plastic DIP	-40°C to +85°C	CLC406AJP	CLC406AJP	N08E
8-pin plastic SOIC	-40°C to +85°C	CLC406AJE	CLC406AJE	M08A
5-pin SOT	-40°C to +85°C	CLC406AJM5	A17	MA05A

Absolute Maximum Ratings (Note 1)

If Military/Aerospace specified devices are required, please contact the National Semiconductor Sales Office/Distributors for availability and specifications.

Supply Voltage (V_{CC}) $\pm 7V$

I_{OUT}
Output is short circuit protected to ground, but maximum reliability will be maintained if I_{OUT} does not exceed...

70mA

Common Mode Input Voltage $\pm V_{CC}$

Differential Input Voltage 10V

Junction Temperature $+150^{\circ}C$

Operating Temperature Range $-40^{\circ}C$ to $+85^{\circ}C$

Storage Temperature Range $-65^{\circ}C$ to $+150^{\circ}C$

Lead Solder Duration ($+300^{\circ}C$) 10 sec

EDS rating (human body model) 2000V

Operating Ratings

Thermal Resistance

Package	(θ_{JC})	(θ_{JA})
MDIP	$70^{\circ}C/W$	$125^{\circ}C/W$
SOIC	$65^{\circ}C/W$	$145^{\circ}C/W$
SOT23-5	$130^{\circ}C/W$	$150^{\circ}C/W$

Electrical Characteristics

$A_V = +6$, $V_{CC} = \pm 5V$, $R_L = 100\Omega$, $R_f = 500\Omega$; unless specified

Symbol	Parameter	Conditions	Typ	Max/Min Ratings (Note 2)			Units
	Ambient Temperature	CLC406AJ	$+25^{\circ}C$	$-40^{\circ}C$	$+25^{\circ}C$	$+85^{\circ}C$	
Ambient Temperature							
Frequency Domain Response							
SSBW	-3dB Bandwidth	$V_{OUT} < 2V_{PP}$	160	>110	>110	>90	MHz
LSBW		$V_{OUT} < 5V_{PP}$	130	>95	>95	>80	MHz
	Gain Flatness	$V_{OUT} < 2V_{PP}$					
GFPL	Peaking	DC to 25MHz	0	<0.2	<0.2	<0.2	dB
GFPH	Peaking	$>25MHz$	0	<0.5	<0.5	<0.5	dB
GFR	Rolloff	DC to 50MHz	0	<0.6	<0.6	<1.0	dB
LPD	Linear Phase Deviation	DC to 75MHz	0.2	<0.8	<0.8	<1.2	deg
DG1	Differential Gain, $A_V = +2$	$R_L = 150\Omega$, 3.58MHz	0.02	<0.04	<0.04	<0.04	%
DG2		$R_L = 150\Omega$, 4.43MHz	0.02	<0.04	<0.04	<0.04	%
DP1	Differential Phase, $A_V = +2$	$R_L = 150\Omega$, 3.58MHz	0.02	<0.04	<0.04	<0.08	deg
DP2		$R_L = 150\Omega$, 4.43MHz	0.025	<0.05	<0.05	<0.10	deg
Time Domain Response							
TRS	Rise and Fall Time	2V Step	2.2	<3.0	<3.0	<3.9	ns
TRL		4V Step	3.0	<3.6	<3.6	<5.0	ns
TS	Settling Time to 0.05 %	2V Step	12	<18	<18	<20	ns
OS	Overshoot	2V Step	8	<15	<15	<15	%
SR	Slew Rate		1500	>1200	>1200	>1000	V/ μs
Distortion And Noise Response							
HD2	2nd Harmonic Distortion	$2V_{PP}$, 20MHz $R_L = 100\Omega$	-46	<-42	<-42	<-38	dBc
HD2L		$2V_{PP}$, 10MHz $R_L = 1k\Omega$	-68	<-62	<-62	<-60	dBc
HD3	3rd Harmonic Distortion	$2V_{PP}$, 20MHz $R_L = 100\Omega$	-50	<-46	<-46	<-42	dBc
HD3L		$2V_{PP}$, 10MHz $R_L = 1k\Omega$	-75	<-70	<-70	<-65	dBc
	Equivalent Input Noise						
VN	Non Inverting Voltage	$>1MHz$	2.7	3.4	3.4	3.8	nV/ \sqrt{Hz}

Electrical Characteristics (Continued)

$A_V = +6$, $V_{CC} = \pm 5V$, $R_L = 100\Omega$, $R_f = 500\Omega$; unless specified

Symbol	Parameter	Conditions	Typ	Max/Min Ratings (Note 2)			Units
Distortion And Noise Response							
ICN	Inverting Current	>1MHz	11.0	13.9	13.9	15.5	$\mu A/\sqrt{Hz}$
NCN	Non Inverting Current	>1MHz	2.1	2.6	2.6	3.0	$\mu A/\sqrt{Hz}$
SNF	Total Noise Floor	>1MHz	-157	<-156	<-156	-155	dBm_{1Hz}
INV	Total Integrated Noise	1MHz to 100MHz	31	<38	<38	<42	μV
Static, DC Performance							
VIO	Input Offset Voltage (Note 3)		2	<10	<6	<12	mV
DVIO	Average Temperature Coefficient		30	<60	-	<60	$\mu V/^\circ C$
IBN	Input Bias Current (Note 3)	Non Inverting	5	<24	<12	<12	μA
DIBN	Average Temperature Coefficient		30	<125	-	<50	$nA/^\circ C$
IBI	Input Bias Current (Note 3)	Inverting	3	<23	<15	<20	μA
DIBI	Average Temperature Coefficient		20	<100	-	<50	$nA/^\circ C$
PSRR	Power Supply Rejection Ratio		50	>46	>46	>44	dB
CMRR	Common Mode Rejection Ratio		50	>45	>45	>43	dB
ICC	Supply Current (Note 3)	No Load	5.0	<7.0	<6.7	<6.7	mA
Miscellaneous Performance							
RIN	Non Inverting Input Resistance		1000	>300	>500	>500	k Ω
CIN	Non Inverting Input Capacitance		1.0	<2.0	<2.0	<2.0	pF
RO	Output Impedance	DC	0.2	<0.6	<0.3	<0.2	Ω
VO	Output Voltage Range	$R_L = 100\Omega$	+3.1, -2.7	+1.6, -2.5	± 2.7	± 2.7	V
CMIR	Common Mode Input Range		± 2.2	± 1.4	± 2.0	± 2.0	V
IO	Output Current		70	30	50	50	mA

Note 1: "Absolute Maximum Ratings" are those values beyond which the safety of the device cannot be guaranteed. They are not meant to imply that the devices should be operated at these limits. The table of "Electrical Characteristics" specifies conditions of device operation.

Note 2: Max/min ratings are based on product characterization and simulation. Individual parameters are tested as noted. Outgoing quality levels are determined from tested parameters.

Note 3: AJ-level: spec. is 100% tested at + 25°C.

Typical Performance Characteristics $T_A = 25^\circ\text{C}$, $A_V = +6\text{V}$, $V_{CC} = \pm 5\text{V}$, $R_L = 100\Omega$, $R_f = 500\Omega$; unless specified

Non-Inverting Frequency Response

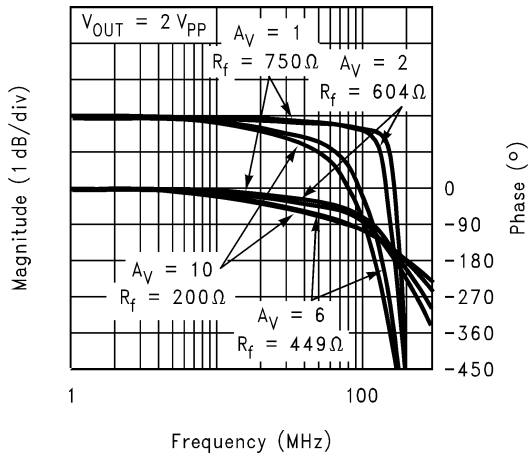

Inverting Frequency Response

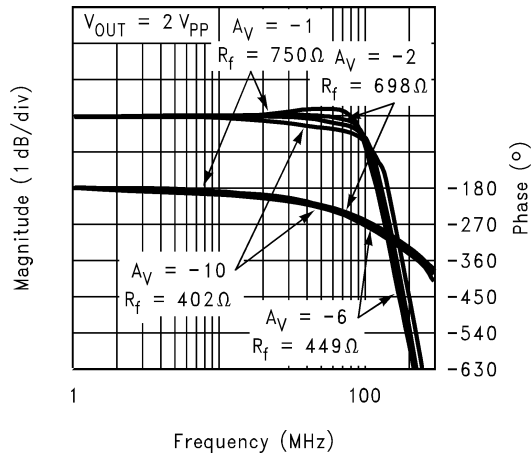

Large Signal Inverting Frequency Response

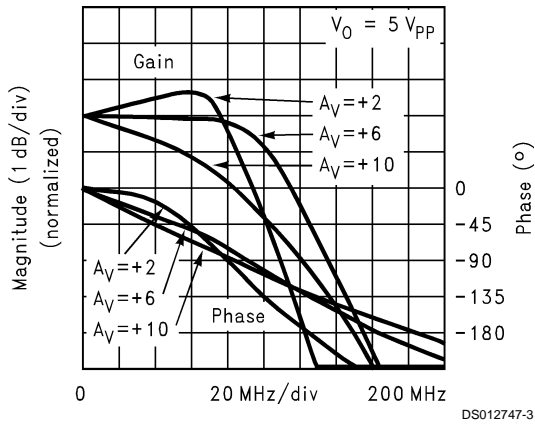

Small Signal Pulse Response

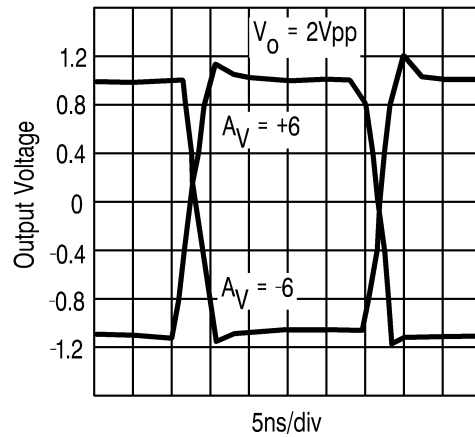

Short-Term Settling Time

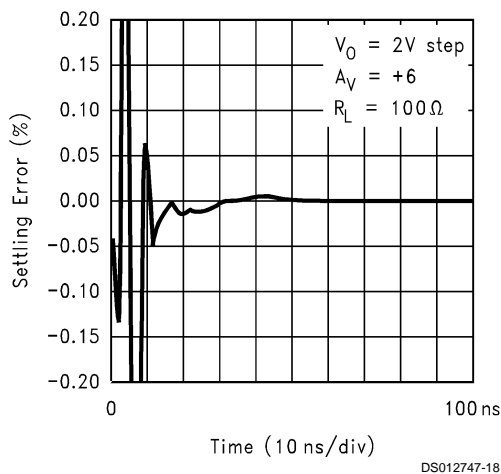

Long-Term Settling Time

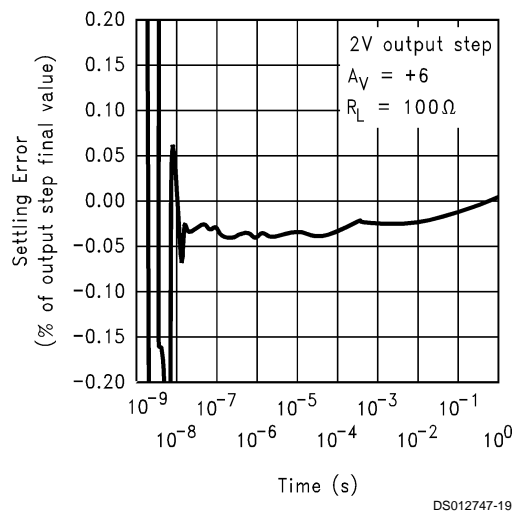

Typical Performance Characteristics $T_A = 25^\circ\text{C}$, $A_V = +6\text{V}$, $V_{CC} = \pm 5\text{V}$, $R_L = 100\Omega$, $R_f = 500\Omega$; unless specified (Continued)

Harmonic Distortion

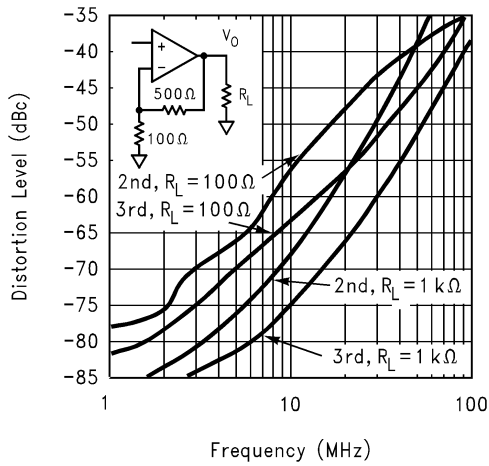

DS012747-4

2-Tone, 3rd Order, Spurious Levels

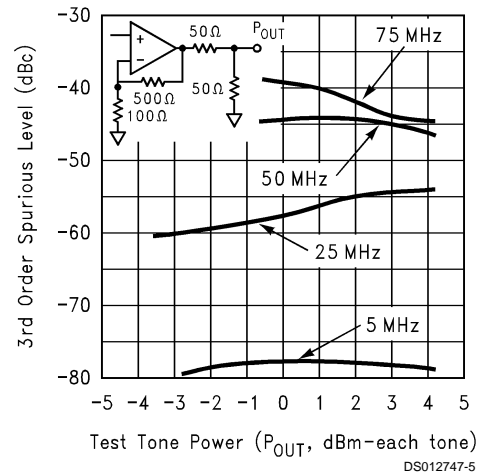

DS012747-5

R_S and Settling Time vs. Capacitive Load

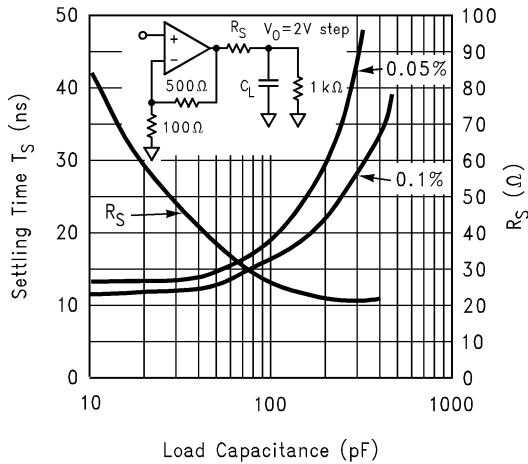

DS012747-6

2nd Harmonic Distortion vs. Output Power

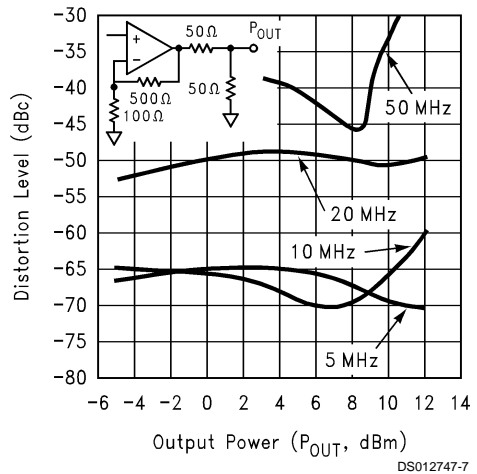

DS012747-7

3rd Harmonic Distortion vs. Output Power

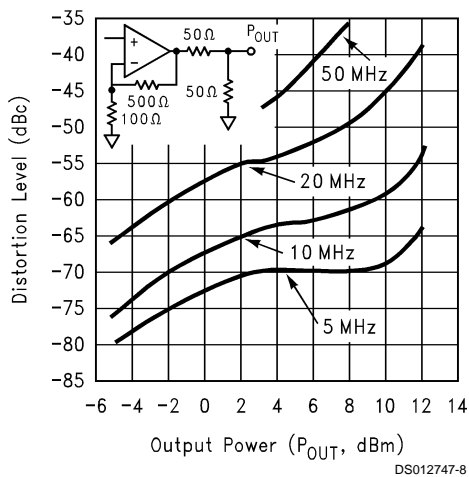

DS012747-8

Differential Gain and Phase (4.43MHz Video)

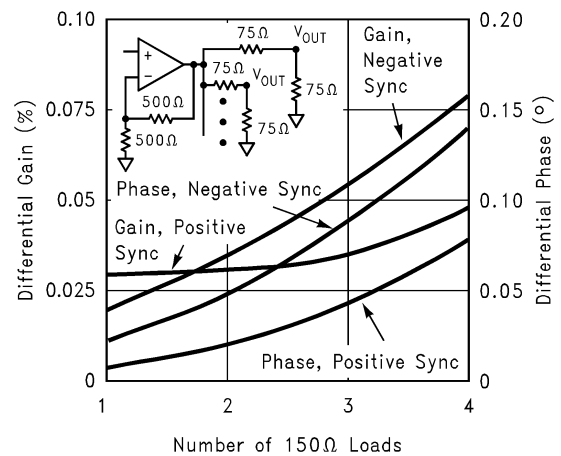

DS012747-9

Typical Performance Characteristics $T_A = 25^\circ\text{C}$, $A_V = +6\text{V}$, $V_{CC} = \pm 5\text{V}$, $R_L = 100\Omega$, $R_f = 500\Omega$;
 unless specified (Continued)

Equivalent Input Noise

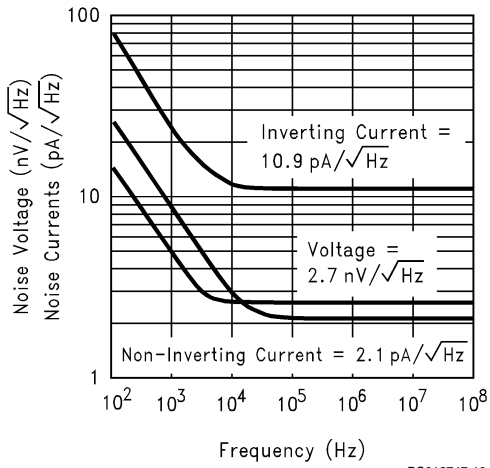

PSRR, CMRR, and Closed Loop R_O

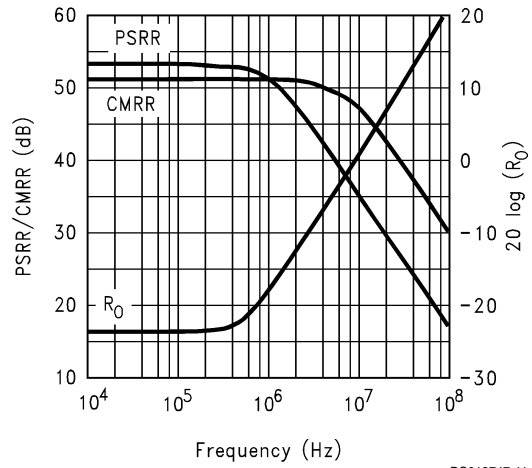

Open-Loop Transimpedance Gain, $Z(s)$

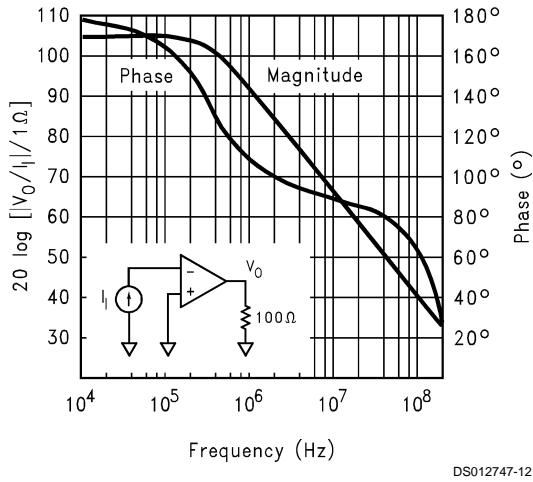

Application Division

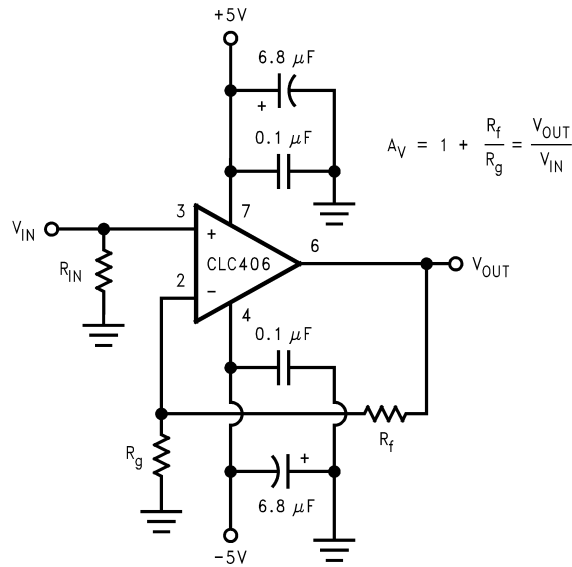

DS012747-13

FIGURE 1. Recommended Non-Inverting Gain Circuit

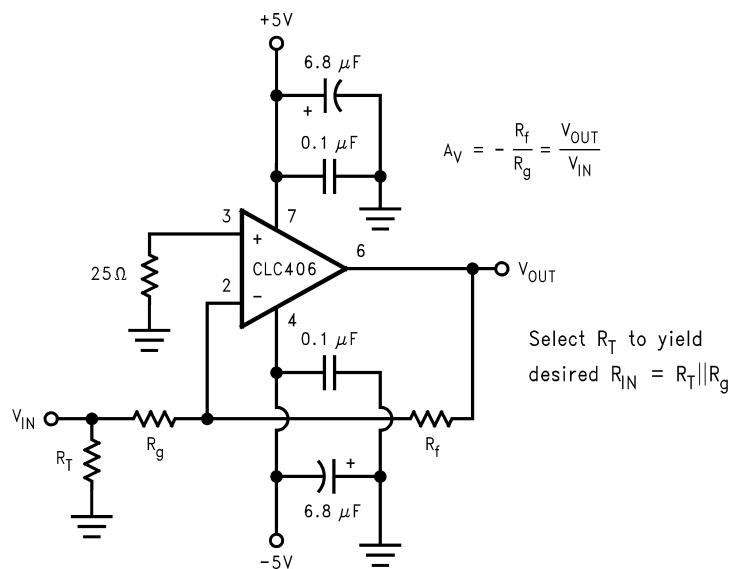

DS012747-14

FIGURE 2. Recommended Inverting Gain Circuit

Feedback Resistor

The CLC406 achieves its exceptional AC performance while requiring very low quiescent power by using the current feedback topology and an internal slew rate enhancement circuit. The loop gain and frequency response for a current feedback op amp is predominantly set by the feedback resistor value. The CLC406 is optimized for a gain of +6 to use a 500Ω feedback resistor (**for maximally flat response at a gain of +2, use $R_f = 1\text{k}\Omega$**). Using lower values can lead to excessive ringing in the pulse response while a higher value will limit the bandwidth. Application Note OA-13 provides a more detailed discussion of choosing a feedback resistor. A plot found within the CLC415 data sheet entitled "Recommended R_f vs. Gain" is also applicable to the CLC406. The values of R_f found on this plot will optimize the performance of the CLC406 over its ± 1 to ± 10 gain range.

The CLC406, like all current feedback op amps, can be operated at higher than recommended gains with an expected reduction in bandwidth.

Slew Rate and Harmonic Distortion

The current feedback topology yields an inherently high slew rate amplifier. For this reason the CLC406 shows little difference in bandwidth between 2V_{PP} and 5V_{PP} outputs. The dominant slew rate limiting mechanism is the unity gain buffer used internally from the non-inverting to the inverting inputs. Using a slew enhancement circuit to sense the onset of slew limiting, the buffer stage momentarily increases the quiescent current to handle high slew requirements. Slew rates will decrease when operating the CLC406 at lower non-inverting gains due to the increasing signal swing through the buffer stage which is necessary to maintain a fixed desired output swing. Conversely, slew rates are

Application Division (Continued)

generally higher and relatively insensitive to gain setting for inverting gain operation. An additional discussion of slew rates can be found in the CLC404 data sheet.

As the output signal swing is increased, the slew enhancement circuit found in the buffer stage acts to suppress harmonic distortions. This is one reason the CLC406 does not exhibit a simple relationship between output power and distortion. For example, the 2-tone, 3rd order spurious plot shows the spurious level to remain nearly constant over test tone power. For this reason the CLC406 does not exhibit an intercept type performance where the relative spurious levels change at twice the rate of the test tone power.

Differential Gain and Phase

Differential gain and phase performance specifications are common to composite video distribution applications. These specifications refer to the change in small signal gain and phase of the color subcarrier frequency (4.43MHz for PAL composite video) as the amplifier output is swept over a range of DC voltages. For this test only, the CLC406 is specified at a gain of +2 while connected to one or more doubly terminated 75Ω loads. Application Note OA-08 provides an additional discussion of differential gain and phase measurements.

Non-inverting Source Impedance

For best operation, the DC source impedance looking out of the non-inverting input should be less than 3kΩ but greater than 20Ω. Parasitic self oscillations may occur in the input transistors if the DC source impedance is out of this range. This impedance also acts as the gain for the non-inverting input bias and noise currents and therefore can become troublesome for high values of DC source impedance. The inverting configuration of *Figure 2* shows a 25Ω resistor to ground on the non-inverting input which insures stability but does not provide bias current cancellation. The input bias currents are unrelated for a current feedback amplifier which eliminates the need for source impedance matching to achieve bias current cancellation.

DC Accuracy and Noise

Equation 1 shows an example of the output offset voltage computation. The calculation is developed using typical bias current and offset voltage specifications at 25°C, a gain (Av) of +6 and a non-inverting source impedance (R_s) of 25Ω.

Equation 1: Output Offset Voltage Calculation

$$V_O = (\pm I_{bn} R_{in} \pm V_{io})(1 + R_f/R_g) \pm I_{br} R_f \\ V_O = (\pm 5\mu A(25\Omega) \pm 2mV)(6) \pm 3\mu A(500\Omega) = \pm 14.25mV$$

Improved output offset voltage is possible using the composite circuits shown in Application Note OA-07.

The total output spot noise is computed in a similar fashion to the output offset voltage. Using the input spot noise voltage and the two input spot noise currents, the total output spot noise is developed through the same gain equations for each term but combined as the square root of the sum of squared contributing elements. Application Note OA-12 provides a more detailed discussion of noise calculations for current feedback amplifiers.

Printed Circuit Layout

As with any high speed component, a careful attention to the board layout is necessary for optimum performance. Of particular importance is the careful control of parasitic capacitances on the output pin. As the output impedance plot shows, the closed loop output of the CLC406 eventually becomes inductive as the loop gain rolls off with increasing frequency. Direct capacitive loading on the output pin can quickly lead to peaking in the frequency response, overshoot in the pulse response, ringing or even sustained oscillations. The "Suggested Series R_s vs. C" plot should be used as a starting point when a capacitive load must be driven.

Evaluation boards (CLC730013-DIP, CLC730027-SOIC, and CLC730068-SOT) for the CLC406 are available. Further layout suggestions can be found in Application Note OA-15.

Physical Dimensions inches (millimeters) unless otherwise noted

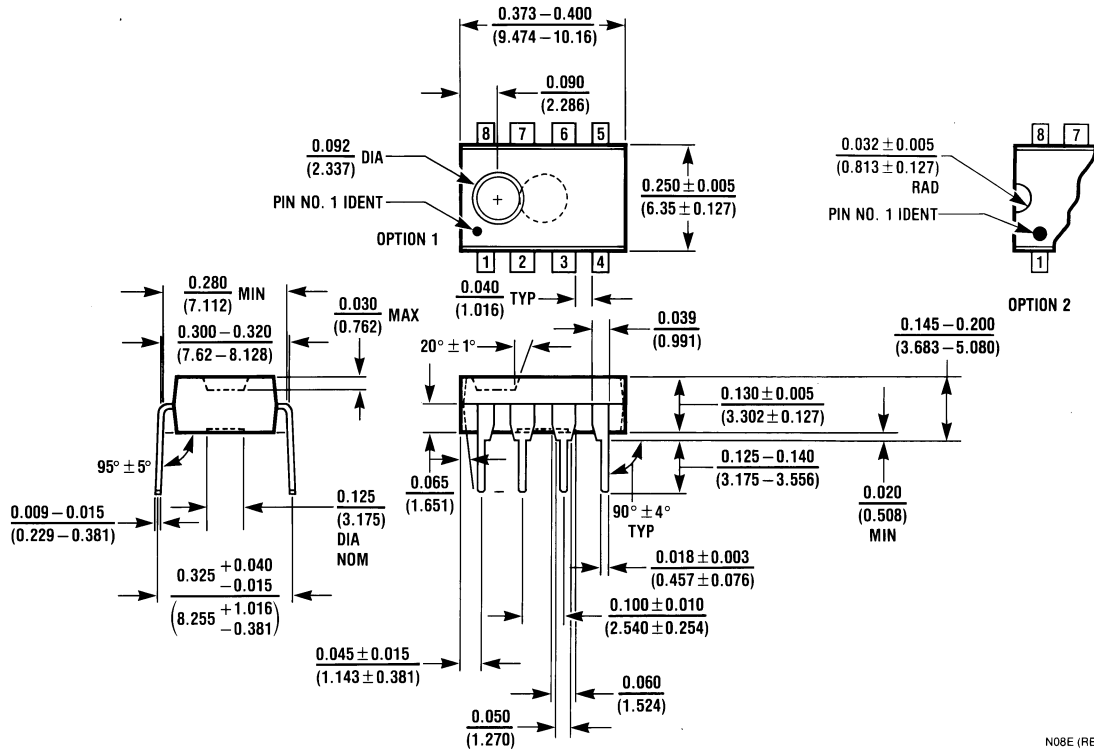

8-Pin MDIP
NS Package Number N08E

N08E (REV F)

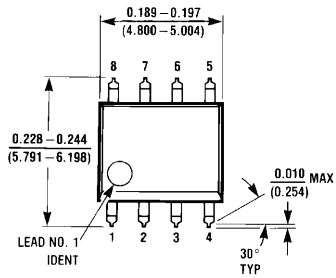

8-Pin SOIC
NS Package Number M08A

M08A (REV H)

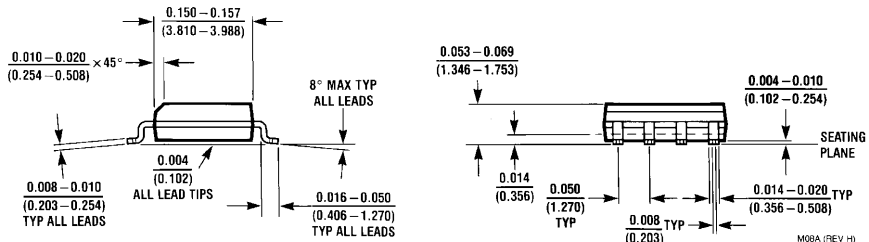

Physical Dimensions inches (millimeters) unless otherwise noted (Continued)

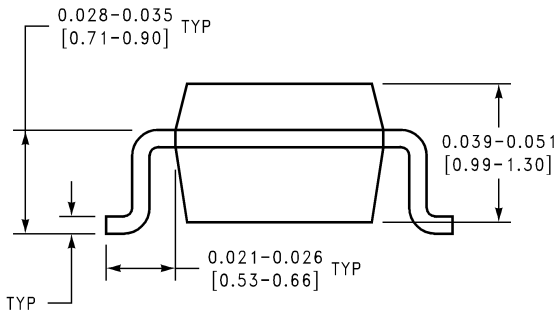
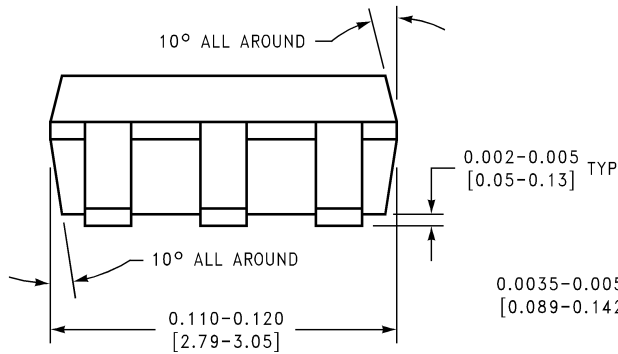
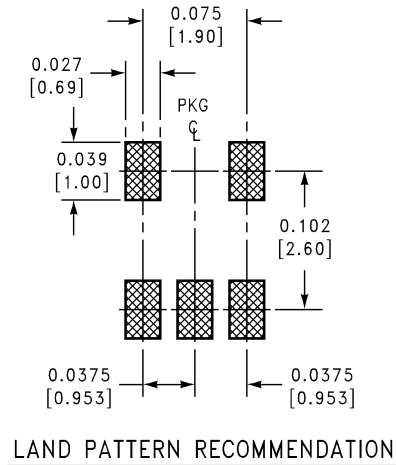
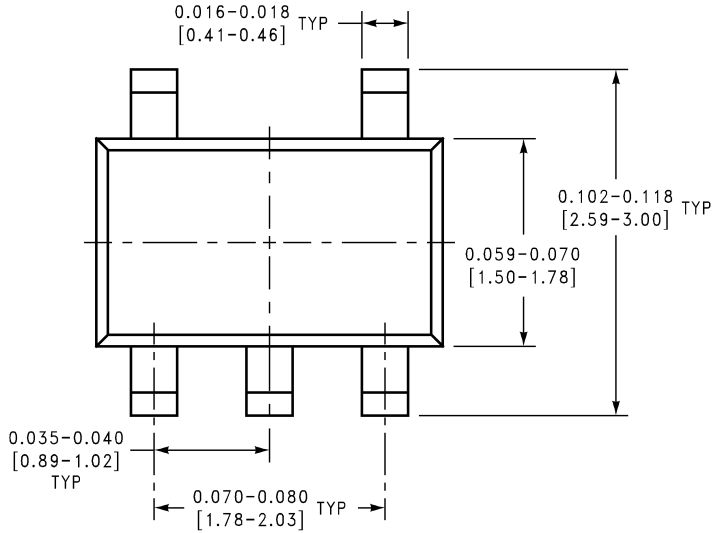

MA05A (REV D)

**5-Pin SOT23
NS Package Number MA05A**

LIFE SUPPORT POLICY

NATIONAL'S PRODUCTS ARE NOT AUTHORIZED FOR USE AS CRITICAL COMPONENTS IN LIFE SUPPORT DEVICES OR SYSTEMS WITHOUT THE EXPRESS WRITTEN APPROVAL OF THE PRESIDENT AND GENERAL COUNSEL OF NATIONAL SEMICONDUCTOR CORPORATION. As used herein:

1. Life support devices or systems are devices or systems which, (a) are intended for surgical implant into the body, or (b) support or sustain life, and whose failure to perform when properly used in accordance with instructions for use provided in the labeling, can be reasonably expected to result in a significant injury to the user.
2. A critical component is any component of a life support device or system whose failure to perform can be reasonably expected to cause the failure of the life support device or system, or to affect its safety or effectiveness.

National Semiconductor Corporation
Americas
Tel: 1-800-272-9959
Fax: 1-800-737-7018
Email: support@nsc.com
www.national.com

National Semiconductor Europe
Fax: +49 (0) 180-530 85 86
Email: europe.support@nsc.com
Deutsch Tel: +49 (0) 69 9508 6208
English Tel: +44 (0) 870 24 0 2171
Français Tel: +33 (0) 1 41 91 8790

National Semiconductor Asia Pacific Customer Response Group
Tel: 65-2544466
Fax: 65-2504466
Email: ap.support@nsc.com

National Semiconductor Japan Ltd.
Tel: 81-3-5639-7560
Fax: 81-3-5639-7507